

OWNER'S MANUAL "PARIS"

ELECTRIC FIREPLACE:
WALL MOUNTED / BUILT-IN



NOBLE FLAME

CE AC 220-240V, 50HZ, 1.400 - 1.600W (PARIS 660: 1.150 - 1.350 W)

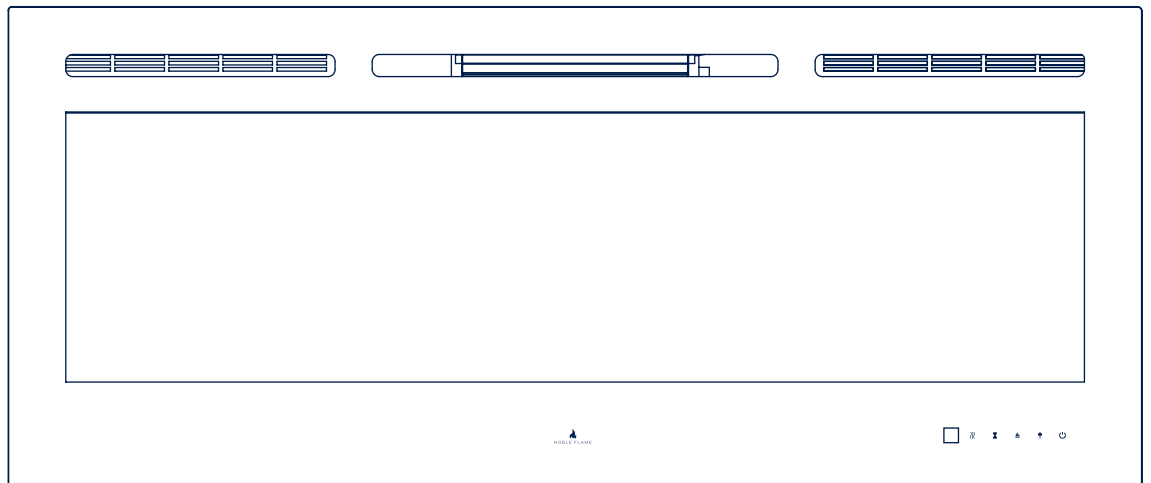

MODEL

- | | | |
|--------------------------------|--------------------------------|--------------------------------|
| <input type="checkbox"/> 660 | <input type="checkbox"/> 1.280 | <input type="checkbox"/> 1.660 |
| <input type="checkbox"/> 920 | <input type="checkbox"/> 1.400 | <input type="checkbox"/> 1.830 |
| <input type="checkbox"/> 1.150 | <input type="checkbox"/> 1.530 | <input type="checkbox"/> 2.540 |

CAUTION

- > Read and understand this entire owner's manual, including all safety information, before plugging in or using this product. Failure to do so could result in fire, electric shock, or serious personal injury.
- > Keep this owner's manual for future reference. If you sell or give this product away, make sure this manual accompanies this product.

IMPORTANT SAFETY INFORMATION!

SAVE THESE INSTRUCTIONS!

- › **Read all instructions before using this heater!**

⚠ CAUTION

- › **This heater is hot when in use.** To avoid burns, **DO NOT** let bare skin touch hot surfaces. If provided, use handles when moving this heater. Keep combustible materials, such as furniture, pillows, bedding, papers, clothes, and curtains at least 3 feet (0.9m) from the front of the heater, and keep them away from the sides and rear.
- › Extreme caution is necessary when any heater is used by or near children or invalids and whenever the heater is left operating and unattended.
- › **DO NOT** operate any heater with a damaged cord or plug or after the heater malfunctions, has been dropped or damaged in any manner. Discard heater, or return to authorized service facility for examination and/or repair.
- › **DO NOT** run power cord under carpeting. **DO NOT** cover power cord with throw rugs, runners, or similar coverings. **DO NOT** route power cord under furniture or appliances. Arrange power cord away from traffic area, and where it will not be tripped over.
- › Connect to properly grounded outlets **ONLY**.
- › **DO NOT** insert or allow foreign objects to enter any ventilation or exhaust opening, as this may cause electric shock or fire, or damage the heater.

⚠ CAUTION

- › **To prevent a possible fire, DO NOT block air intakes or exhaust in any manner. Doing so could cause a fire. DO NOT use on soft surfaces, like a bed, where openings may become blocked.**
- › A heater has hot and arcing or sparking parts inside. **DO NOT** use it in areas where gasoline, paint, or flammable liquids are used or stored.

⚠ CAUTION

- › **Use this heater ONLY as described in this manual. Any other use not recommended by the manufacturer may cause fire, electric shock, or injury to persons.**
- › **ALWAYS** plug heaters directly into a wall outlet/receptacle. If you use a power cord make sure that it supports at least 1.600 W.
- › **DO NOT** place the heater near a bed because objects such as pillows or blankets can fall off the bed and be ignited by the heater.
- › **NEVER** use this heater in bathrooms, laundry rooms, or any other location where the heater could fall into a bathtub or pool, become damp, or get in contact with water.
- › **AVOID FIRE!** Regularly inspect all air vents to make sure they are free from dust, lint, or other blockage. Unplug the unit and clean with a vacuum **ONLY**. **DO NOT** rinse or get wet.
- › **ALWAYS** mount to wall bracket before use. **DO NOT** set on the floor, or other surface, to use.
- › **NEVER** use a wall mount bracket from another manufacturer.

IMPORTANT SAFETY INFORMATION!

SAVE THESE INSTRUCTIONS!

- › This product is not intended to be a primary heat source. It is for supplemental heat only.

CAUTION

- › **INDOOR use only! Never use this heater outdoors! Doing so may result in electric shock!**

CAUTION

- › **Risk of electric shock! Do Not OPEN! No user-serviceable parts inside!**

- › **ALWAYS** turn this heater off before unplugging it from the outlet.
- › **ALWAYS** disconnect this unit from the power supply before performing any assembly or cleaning, or before relocating the electric fireplace.

CAUTION

- › **Never leave this heater unattended. Always unplug this heater when not in use.**

- › **ALWAYS** store this heater in a dry location. **NEVER** use the fireplace if it has become wet.
- › **NEVER** plug this heater into an outlet that is old, cracked, or has any loose wires or connections. Plugging this heater into a faulty outlet could result in electric arcing within the outlet that could cause the outlet to overheat or catch fire.
- › **ALWAYS** check your heater cord and plug connections with each use!
 - a. **MAKE SURE the plug fits tight in the outlet!** Faulty wall outlet connections or loose plugs can cause the outlet to overheat.
 - b. Heaters draw more current than small appliances. Overheating may occur even if it has not occurred with the use of other appliances.
 - c. During use check frequently to see if the plug outlet or face plate is **HOT!**
 - d. If the outlet or face plate is **HOT**, discontinue use immediately and have a qualified electrician inspect and/or replace the faulty outlets.

PREPARATION

CAUTION







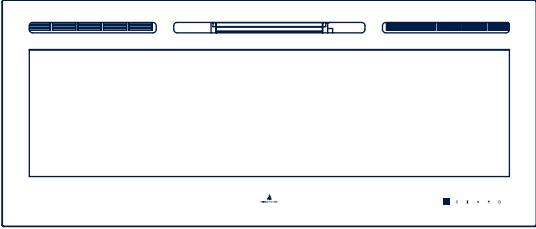

> This product includes a GLASS panel! Always use extreme caution when handling glass. Failure to do so could result in personal injury or property damage.

> Remove all parts and hardware from the carton and place them on a clean, soft, dry surface. Parts and assembly steps are grouped for wall-hanging or recessing use. Check the parts list to make sure nothing is missing. Dispose of packaging materials properly. Please recycle whenever possible.

> **You will need the following tools (not included):**

- > Phillips screwdriver
- > stud finder
- > level
- > tape measure
- > electric drill
- > 1/4" wood drill bit
- > hammer.

PARTS & HARDWARE

 <p>A Fireplace</p>	 <p>D Remote Control</p>	<p>F Decorative Pebbles </p> <p>G Decorative Crystals </p> <p>H Log set </p> <p>I Plastic Tray </p>
 <p>B Wood Screws</p>	 <p>C Drywall anchors</p>	 <p>E Wall Bracket (Fixed on back of firebox)</p>

SPECIFICATION & DIMENSION

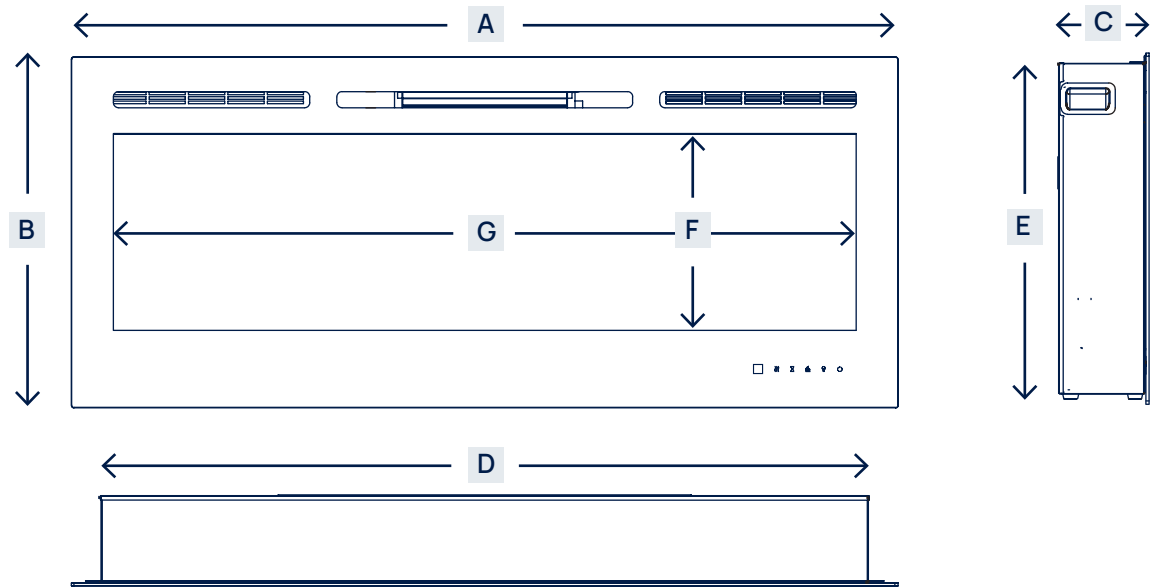

MODEL	A	B	C	D	E	F	G
660	26" 66 cm	16.54" 42 cm	4.88" 12.4 cm	21.08" 53.5 cm	15.60" 39.6 cm	8.66" 22 cm	18.90" 48 cm
920	36" 91.5 cm	21.46" 54.4 cm	5.51" 14 cm	32.48" 82.5 cm	20.51" 52.1 cm	12" 30.5 cm	30.91" 78.5 cm
1150	45" 114.3 cm	21.46" 54.4 cm	5.51" 14 cm	39.88" 101.3 cm	20.51" 52.1 cm	12" 30.5 cm	38.31" 97.3 cm
1280	50" 128 cm	21.46" 54.4 cm	5.51" 14 cm	46.85" 119 cm	20.51" 52.1 cm	12" 30.5 cm	45.28" 115 cm
1400	55" 139.7 cm	21.46" 54.4 cm	5.51" 14 cm	46.85" 119 cm	20.51" 52.1 cm	12" 30.5 cm	45.28" 115 cm
1530	60" 152.4 cm	21.46" 54.4 cm	5.51" 14 cm	46.85" 119 cm	20.51" 52.1 cm	12" 30.5 cm	45.28" 115 cm
1660	65" 165.1 cm	21.46" 54.4 cm	5.51" 14 cm	61.5" 156.1 cm	20.51" 52.1 cm	12" 30.5 cm	59.8" 152.1 cm
1830	72" 182.8 cm	21.46" 54.4 cm	5.51" 14 cm	68.39" 173.72 cm	20.51" 52.1 cm	12" 30.5 cm	66.82" 169.72 cm
2540	100" 254 cm	21.46" 54.4 cm	5.51" 14 cm	96.39" 244.83 cm	20.51" 52.1 cm	12" 30.5 cm	94.8" 240.84 cm

DESCRIPTION	ELECTRIC FIREPLACE
TYPE	3 Way Mounting Unit, Wall-Mount, Recess into Wall and assemble with mantel
VOLTAGE	220V AC
WATTS	MAX 1500W
AMPS	15 AMP Grounded Circuit

INSTALLATION & ASSEMBLY

INSTALLATION

NOTICE

- > Your appliance is a wall-mounted, recessed and/or mantel installed appliance. Select a suitable location that is not susceptible to moisture and is away from drapes, furniture and high traffic areas.

CAUTION

- > Follow all national and local electrical codes.
- > WHEN USING PAINT OR LACQUER TO FINISH THE MANTEL, THE PAINT OR LACQUER MUST BE HEAT RESISTANT TO PREVENT DISCOLOURATION.

MINIMUM CLEARANCE TO COMBUSTIBLES

MEASUREMENTS ARE TAKEN FROM THE GLASS FRONT

BOTTOM	0 mm (0")	TOP	300 mm (11.8") to mantel
SIDES	0 mm (0")	TOP	300 mm (11.8") to ceiling
BACK	0 mm (0")		

SIDE VIEW

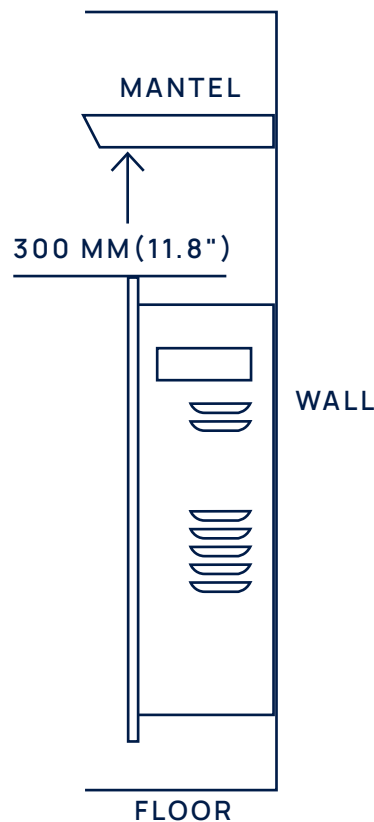

INSTALLATION & ASSEMBLY

RECESSED INTO WALL INSTALLATION

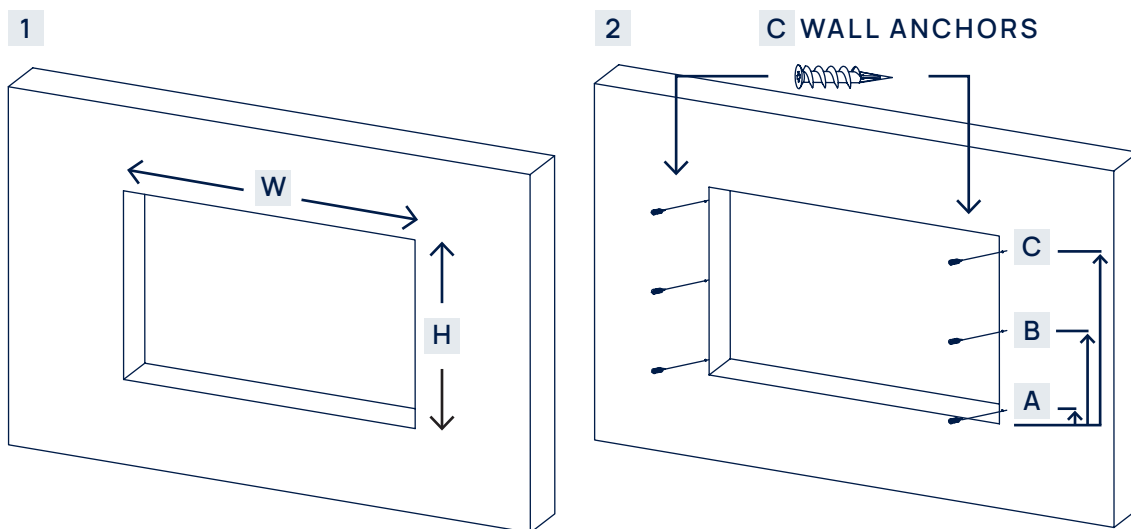

STEP 1

> Selection a dry wall to open a hole for fireplace box. Size of hole as chart below.

MODEL	W	H
660	21.5" (54.61 cm)	16" (40.64 cm)
920	33" (83.82 cm)	20.75" (52.71 cm)
1150	40" (101.6 cm)	20.75" (52.71 cm)
1280	47" (119.38 cm)	20.75" (52.71 cm)
1400	47" (119.38 cm)	20.75" (52.71 cm)
1530	47" (119.38 cm)	20.75" (52.71 cm)
1660	62" (157.48 cm)	20.75" (52.71 cm)
1830	69" (175.26 cm)	20.75" (52.71 cm)
2540	97" (246.38 cm)	20.75" (52.71 cm)

STEP 2

> Fix the three (two for model 660) wall anchors in each side of the fireplace box according to the dimensions in the drawing and the chart below.

MODEL	INCHCES	CM
A	2.12"	5.4 cm
B	10.98"	27.9 cm
C	19.84"	50.4 cm

INSTALLATION & ASSEMBLY

RECESSED INTO WALL INSTALLATION

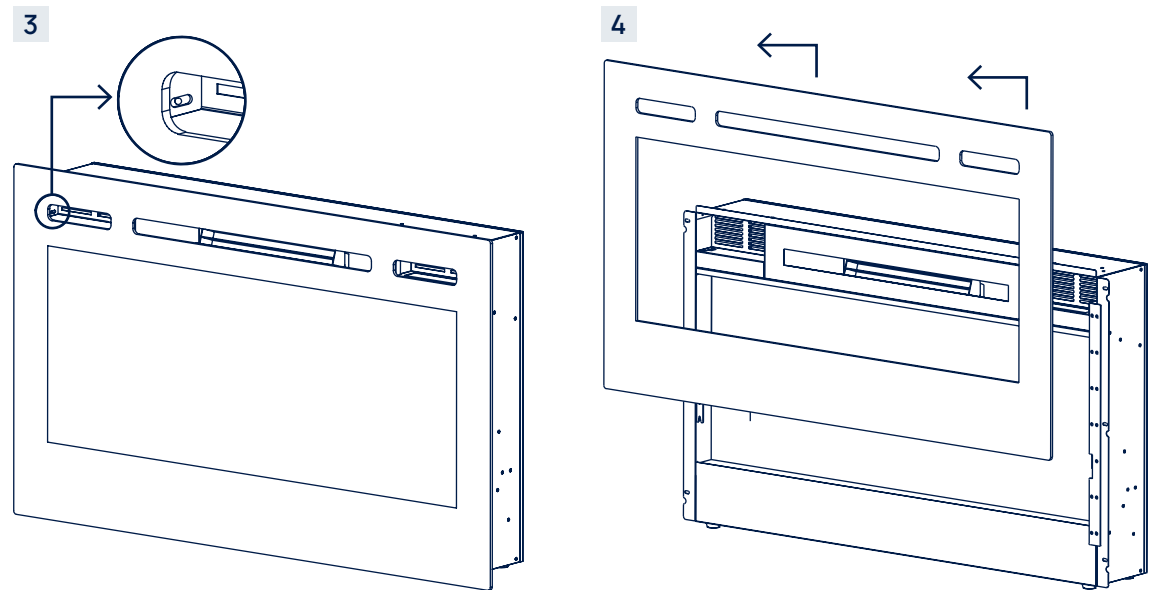

STEP 3

- › Take off the two screws in both sides of the glass panel.

STEP 4

- › You need two persons to take the glass panel out of the fireplace box. Place it on a soft and clean surface.

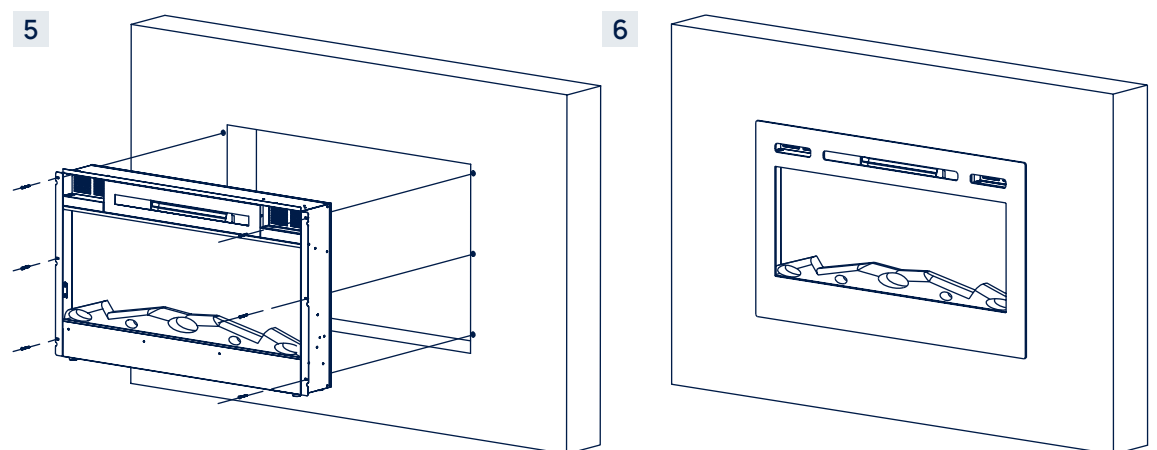

STEP 5

- › You need two persons to move the fireplace box to the wall hole.
- › Use the 6 screws (provided) to lock the appliance into the wall with the existing two side flanges.
- › Install the media (see Page 10) and re-install the glass front.

STEP 6

- › Fireplace will look like this after installation.

INSTALLATION & ASSEMBLY

WALL MOUNTED INSTALLATION

- > Due to the many different materials used on different walls, it is highly recommended that you consult your local builder before you install this appliance on the wall.
- > **You need two people to install the fireplace on a wall.**

STEP 1

- > Select a location that is not prone to moisture and is located at least 36" (914mm) away from combustible materials such as curtain drapes, furniture, bedding, paper, etc.

STEP 2

- > Have two people hold the appliance against the wall to determine the final location.

STEP 3

- > Place unit face down on a soft, nonabrasive surface. Remove the bracket from the back of the unit by removing the screws, refer to Figure 1.

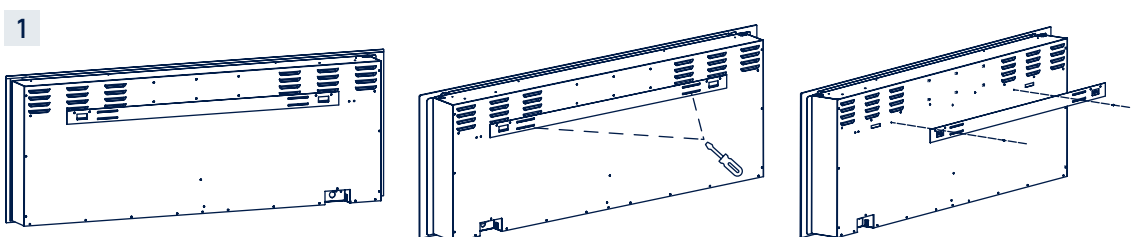
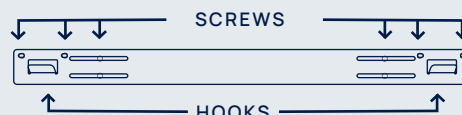

- > Illustration of wall bracket for models 660, 920, 1150, 1280, 1400, 1530

STEP 4

- > Mark out location, then mount the bracket(s) onto the wall using the supplied screws. This bracket **MUST** have the hooks facing upward and be level.

NOTICE

- > It is strongly recommended that the mounting bracket (E) be screwed into the wall studs where possible. If the wall studs cannot be used, ensure that the supplied plastic anchors are used to affix the bracket to the wall and the bracket is adequately secured.

STEP 5

- > With the wall mounting bracket installed have two people lift the appliance up and insert the two hooks on the bracket into the two slots on the back of the appliance.

STEP 6

- > Check the appliance for stability ensuring that the bracket will not pull free from the wall.

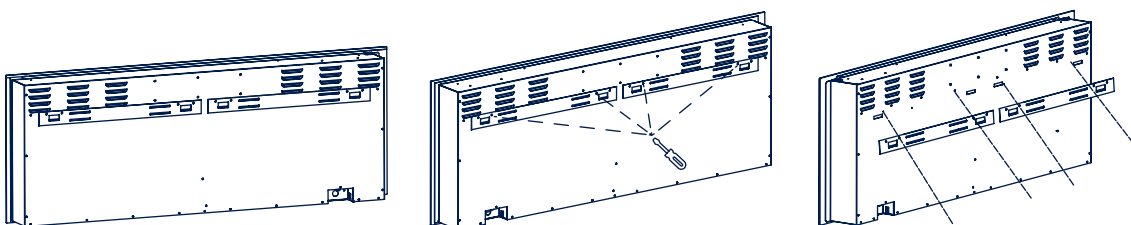

- > Illustration of wall bracket for models 1660, 1830, 2540

LOGSET / CRYSTAL / PEBBLE EMBER INSTALLATION

PLEASE PERFORM THE INSTALLATION ACCORDING TO THE MEDIA YOU PURCHASED OR SELECTED.

STEP 1

- › Glass front must be removed and the appliance must be mounted in its final location before the logset / crystal / pebble embers are installed.

STEP 2

- › **Logset:** If your fireplace come with logset, remove the logset from the package, put it to the fireplace designed place.

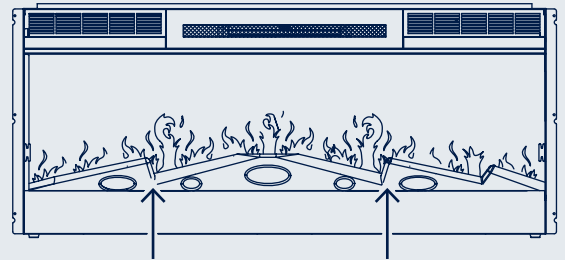

STEP 3

- › **Crystal or Pebbel Media:** Crystal or pebbles media may have a fine oil residue that needs to be cleaned prior to installation. Clean the them with mild dish soap, drain, rinse thoroughly and dry before placing into the tray.

STEP 4

- › Place the plastic tray (1) to the fireplace designed place. Then carefully place crystal or pebbles embers into the bottom tray on the front of the appliance as illustrated. Apply an even layer from side to side.

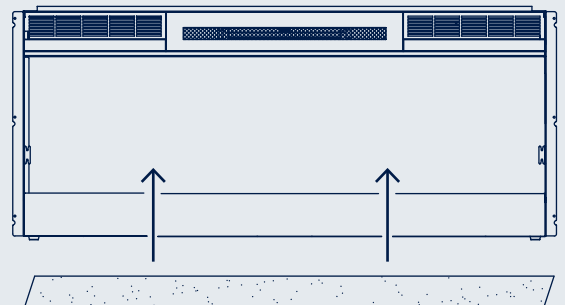

OPERATION

CAUTION

- › Read and understand this entire owner's manual, including all safety information, before plugging in or using this product. Failure to do so could result in electric shock, fire, serious injury, or death.

POWER

- › Plug the power cord into a **220-240 Volt 15 Amp** grounded outlet (see **IMPORTANT SAFETY INFORMATION** on Pages 2 and 3). Make sure the outlet is in good condition and that the plug is not loose. **NEVER exceed the maximum amperage for the circuit. DO NOT** plug other appliances into the same circuit.

NOTICE

- › When the heater is first turned on, a slight odor may be present. This is normal and should not occur again unless the heater is not used for a long period of time.

NOTICE

- › To improve operation, aim the remote control at the front of the fireplace. **DO NOT** press the buttons too quickly. Give the unit time to respond to each command.

METHODS OF OPERATION

- › This electric fireplace can be operated by the TOUCH PANEL, located on the **BOTTOM right side** glass panel of the fireplace, or by the battery-powered **REMOTE CONTROL**.
- › The operation and functions of the two methods are the same.
- › Before operating, please review the **IMPORTANT SAFETY INFORMATION** on Pages 2 and 3, and heed all warnings.

FRONT VIEW







TOUCH PANEL

HOTEL-MODE

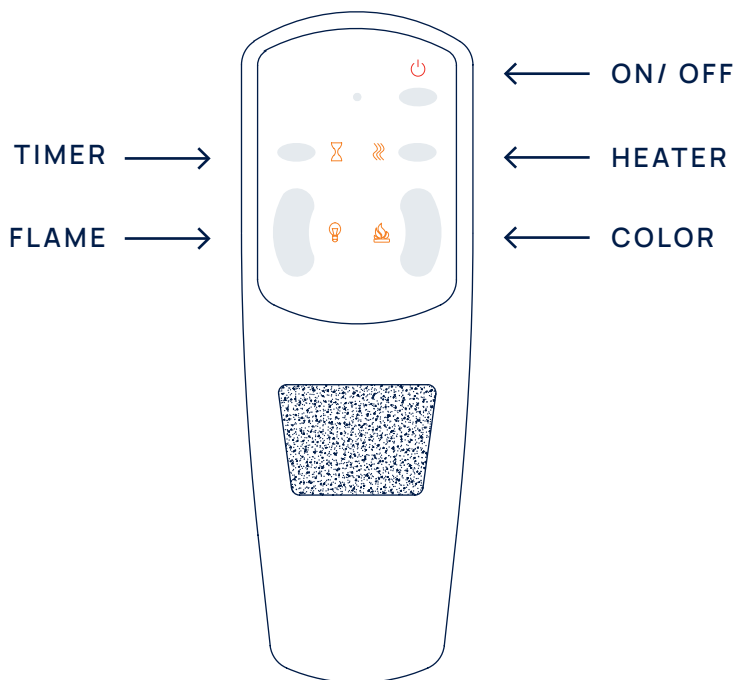
- › By using this mode, your individual settings for the following functions will be retained not only after you turn off the power on the touch panel or remote control, but also when you disconnect the power:
 - › **Flame color**
 - › **Flame brightness**
 - › **Backlight Color**
- › The settings for heating, temperature and timer are not saved and are automatically reset to default after power off.

REMOTE CONTROL



BUTTON	FUNCTION	ACTION & INDICATION
 POWER	<p>ON: Enables control panel functions and remote control. Turns on flame effect.</p> <p>OFF: Disables control panel functions and remote control. Turns off flame effect.</p>	<ol style="list-style-type: none"> Press once: Indicator light turns on. Power turns on. All functions enabled. Press again: Flame effect turns off. Unit goes to standby. All functions turn off.
 TIMER	<p>TIMER BUTTON: Controls timer settings to turn off fireplace at selected time.</p> <p>Settings range from 0.5 hours to 7.5 hours.</p>	<ol style="list-style-type: none"> Press once: Indicator light turns on. Timer is set to 0.5 hours. Press again until desired setting is reached. Indicator lights show setting.
 FLAME	<p>FLAME BUTTON: Makes flame effect dimmer and brighter.</p> <p>NOTE: Flame effect stays on until power button is turned off. Flame effect must be on for heater to turn on.</p>	<ol style="list-style-type: none"> Press once: Flame brightness effect gets changing. Press again until desired setting is reached.
 COLOR	<p>COLOR BUTTON: Changes color of the flame effect.</p> <p>NOTE: color effect stays on until power button is turned off. Color flame effect must be on for heater to turn on.</p>	<ol style="list-style-type: none"> Press once: Flame color effect gets changing. Press again until desired setting is reached. Total 3 colors.

REMOTE CONTROL

BUTTON	FUNCTION	ACTION & INDICATION
 HEATER	<p>HEATER BUTTON: Turns Heater ON and OFF.</p> <p>NOTE: The heater only works when the flame effect is on. If the flame effect is off, the heater will not turn on.</p> <p>NOTE: To prevent overheating, the heater fan will blow cool air for 8-10 seconds before the heater turns on, and after the heater turns off.</p>	<ol style="list-style-type: none"> Press once: Indicator lights up. Fan blows cool air for 10 seconds. 750W heater turns on and blows warm air. Press again: Indicator lights up. 1500W heater turns on and blows hot air. Press again: Heaters turn off. The fan blows cool air for 10 seconds to allow heater to cool down, then turns off.

TEMPERATURE LIMITING CONTROL

- › This heater is equipped with a Temperature Limiting Control. Should the heater reach an unsafe temperature, the heater will automatically turn OFF.

TO RESET

1. Turn the ON/OFF switch on the CONTROL PANEL to OFF. Wait 5 minutes.
2. Unplug the power cord from the outlet.
3. Inspect the fireplace to make sure no vents are blocked or clogged with dust or lint. If they are, use a vacuum to clean the vent areas.
4. With the POWER switch in the OFF position, plug the power cord back into the outlet.
5. If the problem continues, have your outlet and wiring inspected by a professional.

REMOTE CONTROL BATTERY INFORMATION

- › Big remote control uses **two AAA batteries** (not included).
- › **NOTE:** Remote control battery used depends on the remote-control type which selected above.

CAUTION

- › **NEVER dispose of batteries in fire.**
- › Failure to observe this precaution may result in an explosion. Dispose of batteries at your local hazardous material processing center.

CARE & MAINTENANCE

CLEANING

⚠ CAUTION

- › **ALWAYS** turn the heater **OFF** and unplug the power cord from the outlet before cleaning, performing maintenance, or moving this fireplace. **Failure to do so could result in electric shock, fire, or personal injury.**
- › **NEVER immerse in water or spray with water.** Doing so could result in electric shock, fire, or personal injury.

METAL

- › Buff using a soft cloth, slightly dampened with a citrus oil-based product.
- › **DO NOT** use brass polish or household cleaners as these products will damage the metal trim.

GLASS

- › Use a good quality glass cleaner sprayed onto the cloth or towel. Dry thoroughly with a paper towel or lintfree cloth.
- › **NEVER** use abrasive cleansers, liquid sprays, or any cleaner that could scratch the surface.

VENTS

- › Use a vacuum or duster to remove dust and dirt from the heater and vent areas.

PLASTIC

- › Wipe gently with a slightly damp cloth and a mild solution of dish soap and warm water.
- › **NEVER** use abrasive cleansers, liquid sprays, or any cleaner that could scratch the surface.

MAINTENANCE

⚠ CAUTION

- › **Risk of electric shock! DO NOT OPEN any panels ! No user-serviceable parts inside!**
- › **ALWAYS** turn the heater **OFF** and unplug the power cord from the outlet before cleaning, performing maintenance, or moving this fireplace. Failure to do so could result in electric shock, fire, or personal injury.

ELECTRICAL AND MOVING PARTS

- › The fan motors are lubricated at the factory and will not require lubrication.
- › Electrical components are integrated in the fireplace and are not serviceable by the consumer.

STORAGE

- › Store heater in a clean dry place when not in use.

⚠ CAUTION

- › **NO SERVICING of the internal or electrical parts should be performed by the consumer. Do not service the unit yourself.**