

# OWNER'S MANUAL „VEGAS STAINLESS STEEL“

ELECTRIC WALLMOUNTED FIREPLACE



NOBLE FLAME

CE AC 220-240V 50HZ 1400-1600W

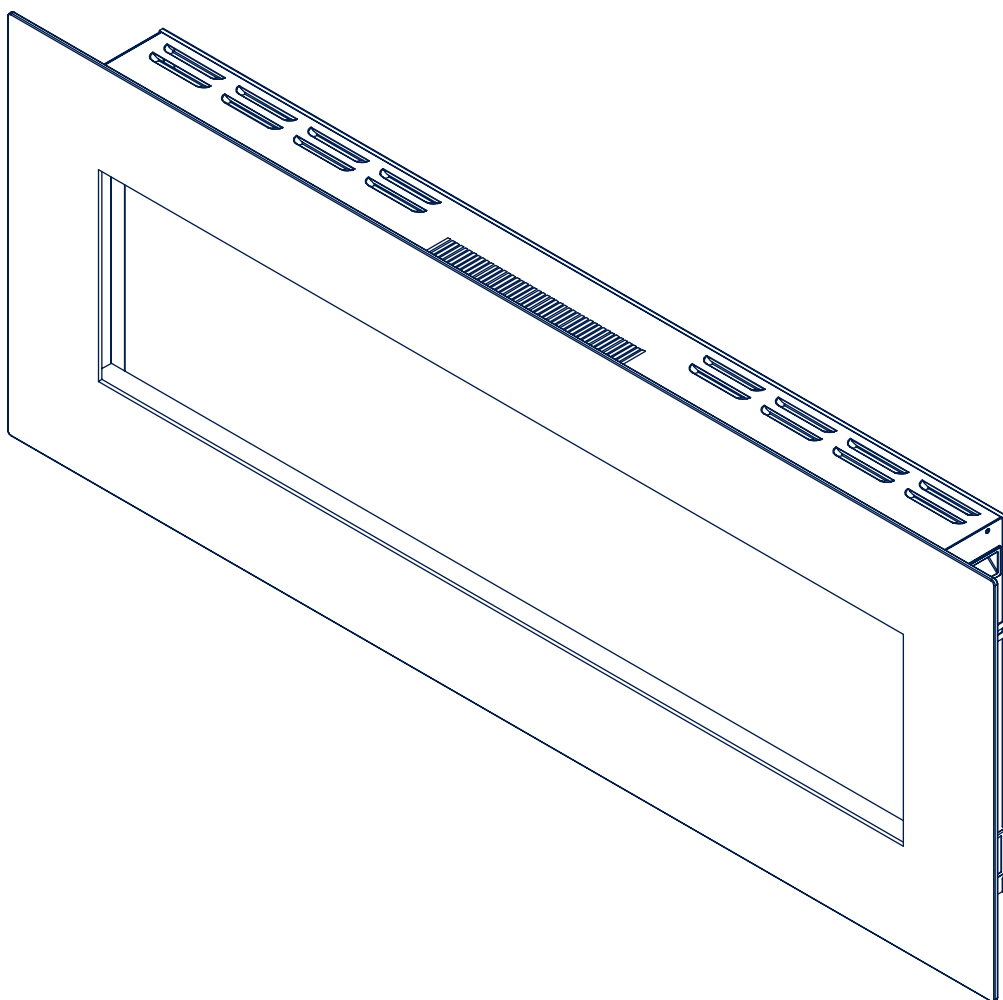

## ⚠ CAUTION

- › Read and understand this entire owner's manual, including all safety information, BEFORE plugging in or using this product. Failure to do so could result in fire, electric shock, or serious personal injury.
- › Keep this owner's manual for future reference. If you sell or give this product away, make sure this manual accompanies this product.

## IMPORTANT SAFETY INFORMATION!

SAVE THESE INSTRUCTIONS!

- › **Read all instructions before using this heater!**

### CAUTION

- › **This heater is hot when in use.**
- › To avoid burns, **DO NOT** let bare skin touch hot surfaces. If provided, use handles when moving this heater. Keep combustible materials, such as furniture, pillows, bedding, papers, clothes, and curtains **at least 3 feet (0.9m)** from the front of the heater and keep them away from the sides and rear.
- › **Extreme caution is necessary when any heater is used by or near children or invalids** and whenever the heater is left operating and unattended.
- › **DO NOT** operate any heater with a damaged cord or plug or after the heater malfunctions, has been dropped or damaged in any manner. Discard heater or return to authorized service facility for examination and/or repair.
- › **DO NOT** run power cord under carpeting. **DO NOT** cover power cord with throw rugs, runners, or similar coverings. **DO NOT** route power cord under furniture or appliances. Arrange power cord away from traffic area, and where it will not be tripped over.
- › Connect to properly grounded outlets **ONLY**.
- › **DO NOT** insert or allow foreign objects to enter any ventilation or exhaust opening, as this may cause electric shock or fire, or damage the heater.
- › To prevent a possible fire, **DO NOT** block air intakes or exhaust in any manner. Doing so could cause a fire. **DO NOT** use on soft surfaces, like a bed, where openings may become blocked.
- › A heater has hot and arcing or sparking parts inside. **DO NOT** use it in areas where gasoline, paint, or flammable liquids are used or stored.
- › **Use this heater only as described in this manual.** Any other use not recommended by the manufacturer may cause fire, electric shock, or injury to persons.
- › **ALWAYS** plug the electric fireplace directly into an electrical outlet and avoid using extension cords. If using an extension cord, check that it is intact and rated for at least 1,875 watts and 14 amps.
- › **DO NOT** place the heater near a bed because objects such as pillows or blankets can fall off the bed and be ignited by the heater.
- › **NEVER** use this heater in bathrooms, laundry rooms, or any other location where the heater could fall into a bathtub or pool, become damp, or come in contact with water.

### CAUTION

- › **AVOID FIRE!**
- › Regularly inspect all air vents to make sure they are free from dust, lint, or other blockage. Unplug the unit and clean with a vacuum **ONLY**. **DO NOT rinse or get wet.**
- › **NEVER** hang this unit on a wall directly below an electrical outlet.
- › **NEVER** permanently install in a recessed area of the wall. This may result in blocked air flow, overheating, or fire.

## IMPORTANT SAFETY INFORMATION!

SAVE THESE INSTRUCTIONS!

- › **ALWAYS** mount to wall bracket before use. **DO NOT** set on the floor, or other surface, to use.
- › **NEVER** use a wall mount bracket from another manufacturer.

### ⚠ CAUTION

- › **INDOOR use only! NEVER use this heater outdoors!** Doing so may result in electric shock!
- › This product is not intended to be a primary heat source. It is for supplemental heat only.

### ⚠ CAUTION









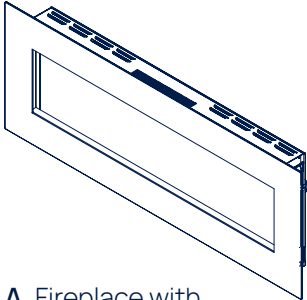

- › **Risk of electric shock! DO NOT OPEN! No user-serviceable parts inside!**
- › **NEVER** modify this heater. Doing so could result in personal injury or property damage. Modification of this fireplace completely voids all warranties.
- › **ALWAYS** turn this heater off before unplugging it from the outlet.
- › **ALWAYS** disconnect this unit from the power supply before performing any assembly or cleaning, or before relocating the electric fireplace.
- › **NEVER** leave this heater unattended. **ALWAYS** unplug this heater when not in use.
- › **ALWAYS** store this heater in a dry location. **NEVER** use the fireplace if it has become wet.
- › **ONLY** use this heater on a **220V AC 15-Amp** grounded circuit. **NEVER** overload the circuit. If this heater trips the circuit breaker, unplug all other appliances on the same circuit before the next use. Avoid plugging other appliances into the same circuit as this heater.
- › **NEVER** plug this heater into an outlet that is old, cracked, or has any loose wires or connections. Plugging this heater into a faulty outlet could result in electric arcing within the outlet that could cause the outlet to overheat or catch fire.
- › **ALWAYS** check your heater cord and plug connections with each use!
  - a. **MAKE SURE** the plug fits tight in the outlet! Faulty wall outlet connections or loose plugs can cause the outlet to overheat.
  - b. Heaters draw more current than small appliances. Overheating may occur even if it has not occurred with the use of other appliances.
  - c. During use check frequently to see if the **plug outlet or face plate is HOT!**
  - d. If the **outlet or face plate is HOT**, discontinue use immediately and have a qualified electrician inspect and/or replace the faulty outlets.

## PREPARATION

### CAUTION

- › This product includes a GLASS panel! Always use extreme caution when handling glass. Failure to do so could result in personal injury or property damage.
- › Remove all parts and hardware from the carton and place them on a clean, soft, dry surface. Parts and assembly steps are grouped for wall-hanging use. Check the parts list to make sure nothing is missing. Dispose of packaging materials properly. Please recycle whenever possible.
- › **You will need the following tools (not included):**
  - › screwdriver
  - › stud finder
  - › level
  - › tape measure
  - › electric drill
  - › 1/4" wood drill bit
  - › hammer

## PARTS & HARDWARE

|  |  |  |   |
|--|--|--|---|
|  <p><b>A</b> Fireplace with hot air vent</p>                      |  <p><b>B</b> Wood screws</p>                                  |  <p><b>D</b> Remote Control</p> | <p><b>F</b> Decorative Pebbels</p>   |
|  |  <p><b>C</b> Drywall anchors</p>                              |  | <p><b>G</b> Decorative Crystals</p>  |
|  |  |  | <p><b>H</b> Log set</p>              |
|  |  |  | <p><b>I</b> Plastic tray</p>         |
| <p><b>D</b> ST4&amp;8 metal screws (fixed with wall bracket)</p>  |  <p><b>E</b> Wall bracket (fixed on the back of firebox)</p> |  |   |

## SPECIFICATION & DIMENSIONS

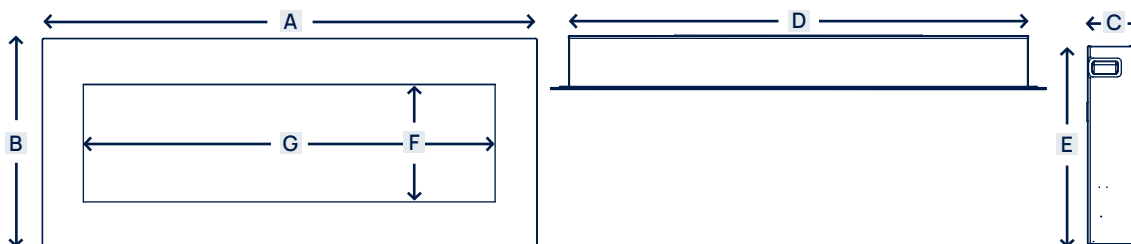

| MODEL             | A             | B            | C             | D                | E              | F            | G              |
|-------------------|---------------|--------------|---------------|------------------|----------------|--------------|----------------|
| <b>VEGAS 1070</b> | 1067mm<br>42" | 508mm<br>20" | 120mm<br>4.7" | 871.8mm<br>34.3" | 450mm<br>17.8" | 255mm<br>10" | 813.8mm<br>32" |

# INSTALLATION & ASSEMBLY

## INSTALLATION

### CAUTION

- › It's required that **TWO CAPABLE ADULTS** to perform this installation.

### NOTICE

- › The wall mount fasteners included with this fireplace are for use **ONLY** with a wood-framed wall covered in drywall (sheet rock). For concrete walls, cinder blocks, or other wall types, consult a professional for the best attachment methods.

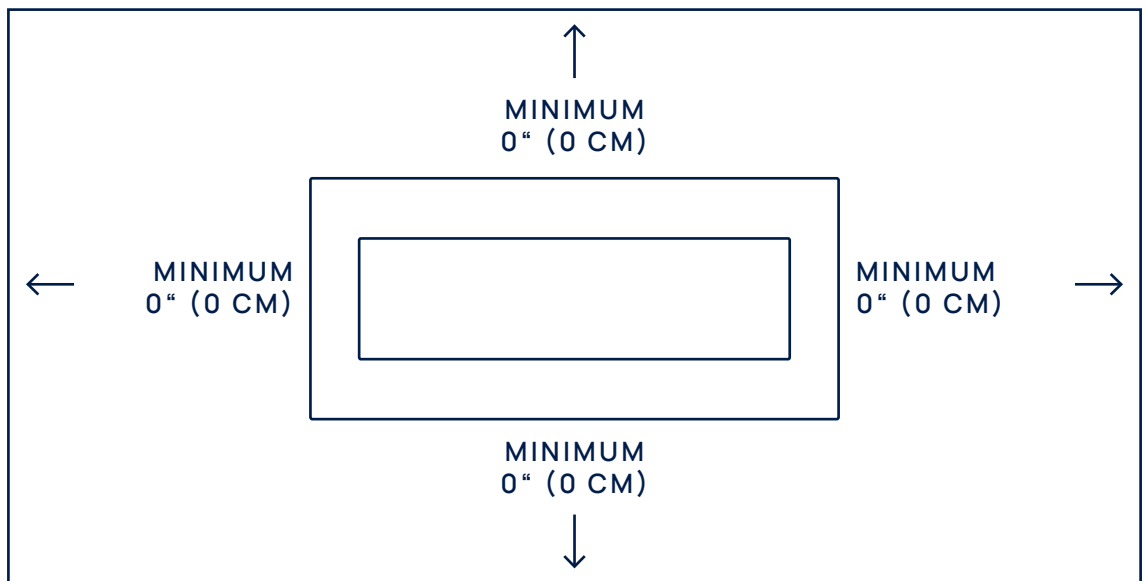

### STEP 1

- › **Find a safe location.**
  - › Minimum clearance on each side: **0" (0 cm)**
  - › Minimum clearance below: **0" (0 cm)**
  - › Minimum clearance above: **0" (0 cm)**
  - › Minimum clearance from the front and sides: **39.4" (100 cm)**
- › Choose a location near an outlet so an extension cord is not required.
- › **DO NOT** position the unit directly below a power outlet.
- › See **Safety Information on pages 2 and 3** for warnings about safe placement, safe installation, and proper use of this product.

# INSTALLATION & ASSEMBLY

## ASSEMBLY

### STEP 1

- > Use a 8 drill bit to drill the holes and use the Hammer to thread the Drywall anchors (C) into the hole till it keep flat with the wall.

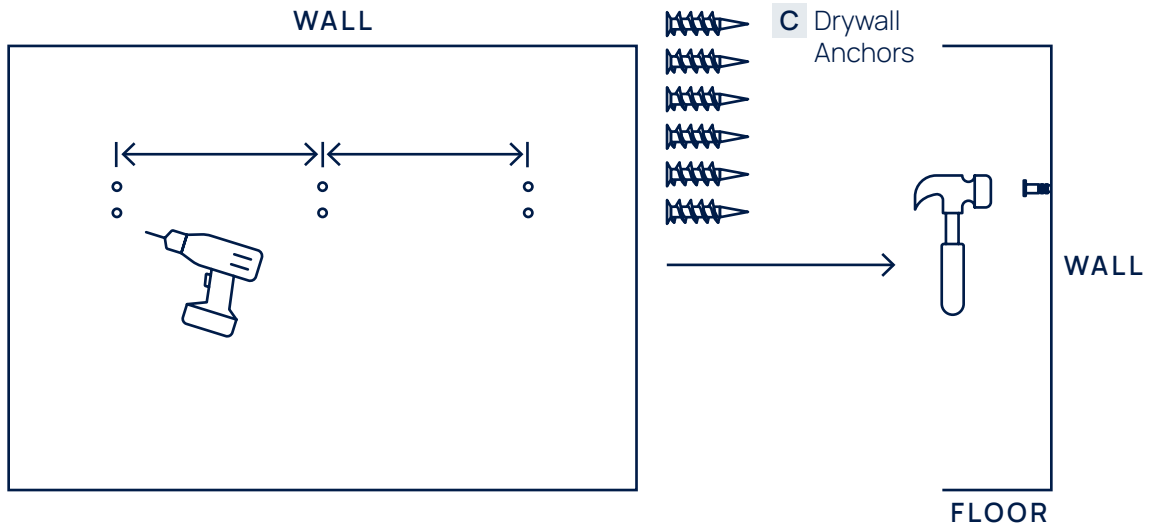

### STEP 2

- > Using the wood screws (B) to fix the wall bracket, with wood screws thread the wall bracket and to lock with the drywall anchors, please tighten all wood screws.

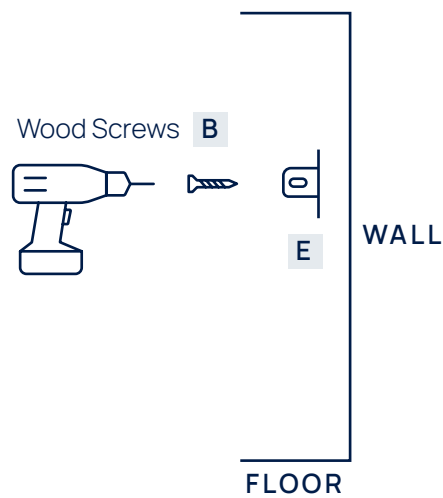

# INSTALLATION & ASSEMBLY

## ASSEMBLY

### STEP 3

- › Have **two people** lift the fireplace machine up and insert the slots (2 slots on back of fireplace box) to the wall bracket hooks.

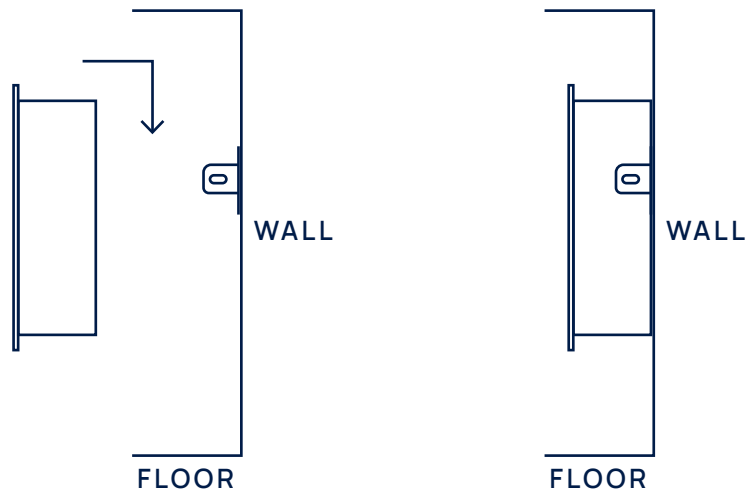

### STEP 4

- › After having installed the fireplace safely, then using screwdriver to lock the bracket and fireplace with two ST4x8 (D) screws in both sides. Check the appliance for stability ensuring that the appliance will not pull free from the wall.

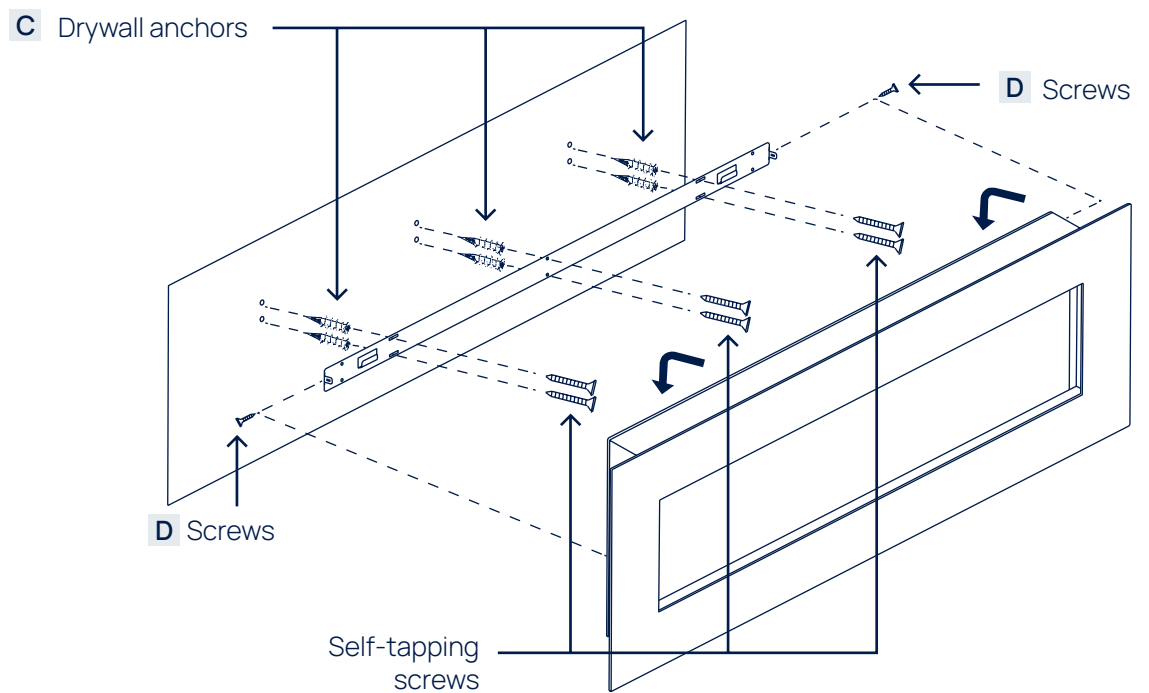

## INSTALLATION & ASSEMBLY

### ASSEMBLY

#### CAUTION

- › This next step involves **GLASS! ALWAYS** use extreme caution when handling glass. Failure to do so could result in personal injury or property damage.

#### CAUTION

- › **ALWAYS** keep the decorative crystals **OUT OF REACH OF CHILDREN!** Leave no pieces where children can find them. **Failure to do so could cause a choking hazard.**

#### NOTICE

- › To place the decorative crystals, follow these steps. **Have a capable adult help you.**

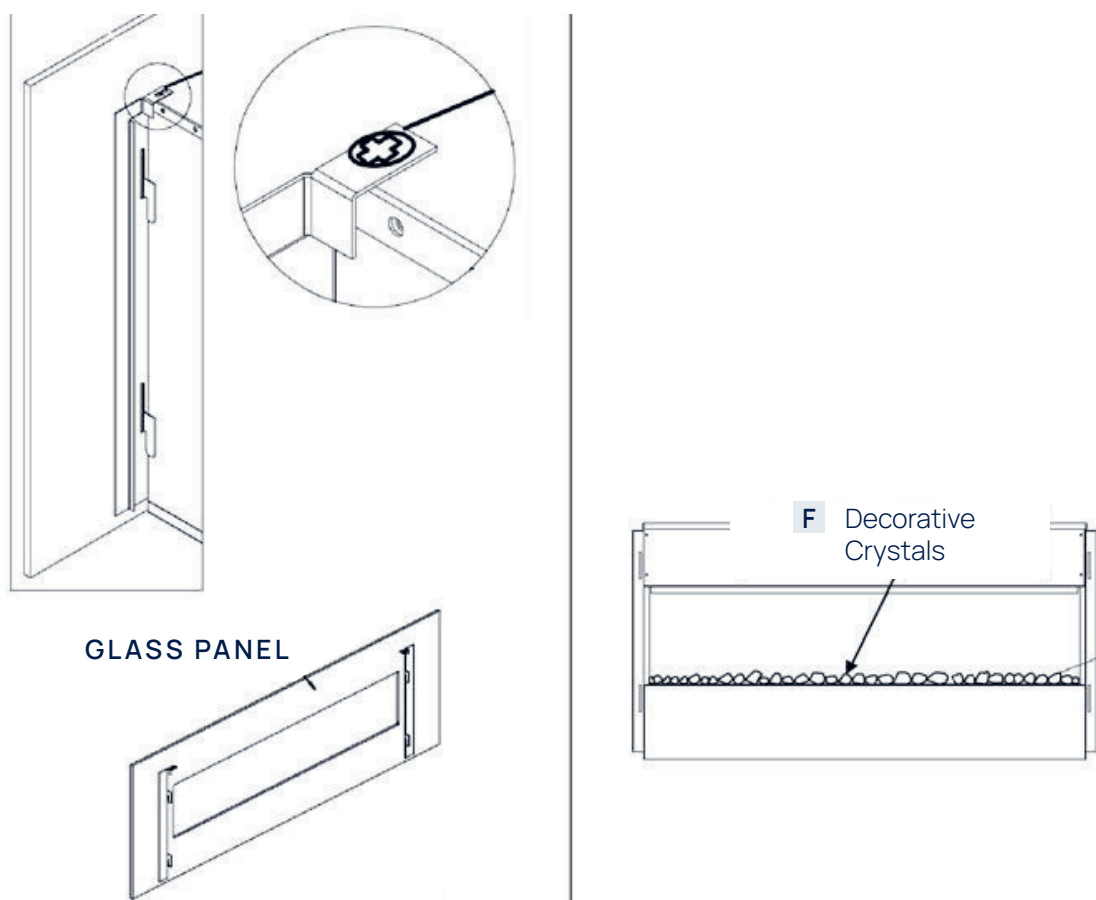

#### STEP 5

- While one person holds the glass panel, remove the two screws at the top edge of the fireplace with a Phillips (+) screwdriver.
- Together, carefully remove the front glass panel and set it aside on a clean soft surface.
- Arrange the log set (**H**) or decorative crystals/pebbles (**F/G**) on the shelf by using the plastic tray in the desired position.
- Set the front glass panel back onto the firebox.
- Align the tabs of the glass panel with the holes on the top edge of the fireplace. Thread the screws back into the holes and tighten them both with a screwdriver.



## OPERATION

### CAUTION

- › Read and understand this entire owner's manual, including all safety information, **BEFORE** plugging in or using this product. Failure to do so could result in electric shock, fire, serious injury, or death.

### POWER

- › Plug the power cord into a **220 Volt 15 Amp** grounded outlet (**see IMPORTANT SAFETY INFORMATION on Pages 2 and 3**).
- › Make sure the outlet is in good condition and that the plug is not loose. **NEVER** exceed the maximum amperage for the circuit.
- › **DO NOT** plug other appliances into the same circuit.

### NOTICE

- › When the heater is first turned on, a slight odor may be present. This is normal and should not occur again unless the heater is not used for a long period of time.

### NOTICE

- › To improve operation, aim the remote control at the front of the fireplace. **DO NOT** press the buttons too quickly. Give the unit time to respond to each command.

### METHODS OF OPERATION



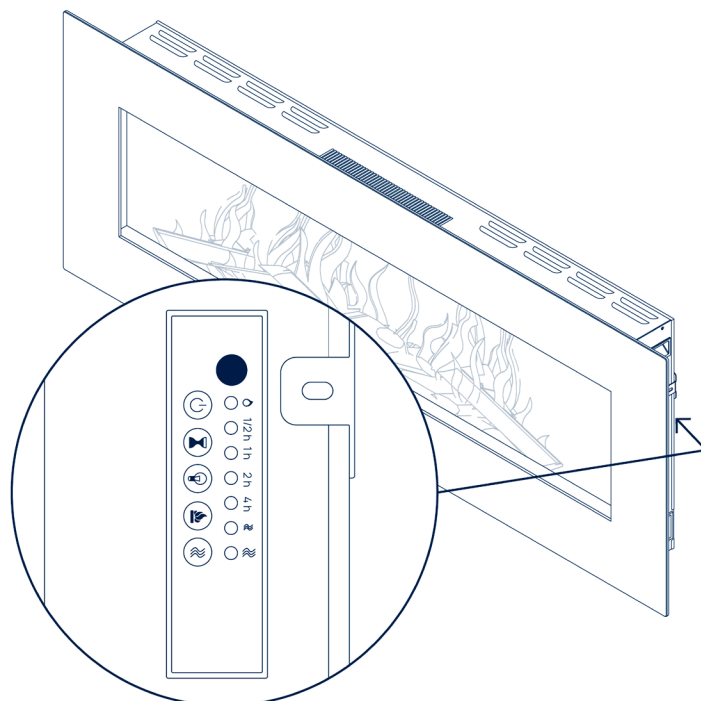

- › This electric fireplace can be operated by the **MANUAL PANEL** located on the right side of the device, or by the battery-powered **REMOTE CONTROL**.
- › The operation and functions of methods are the same.
- › Before operating, please review the **IMPORTANT SAFETY INFORMATION on Pages 2 and 3** and heed all warnings.



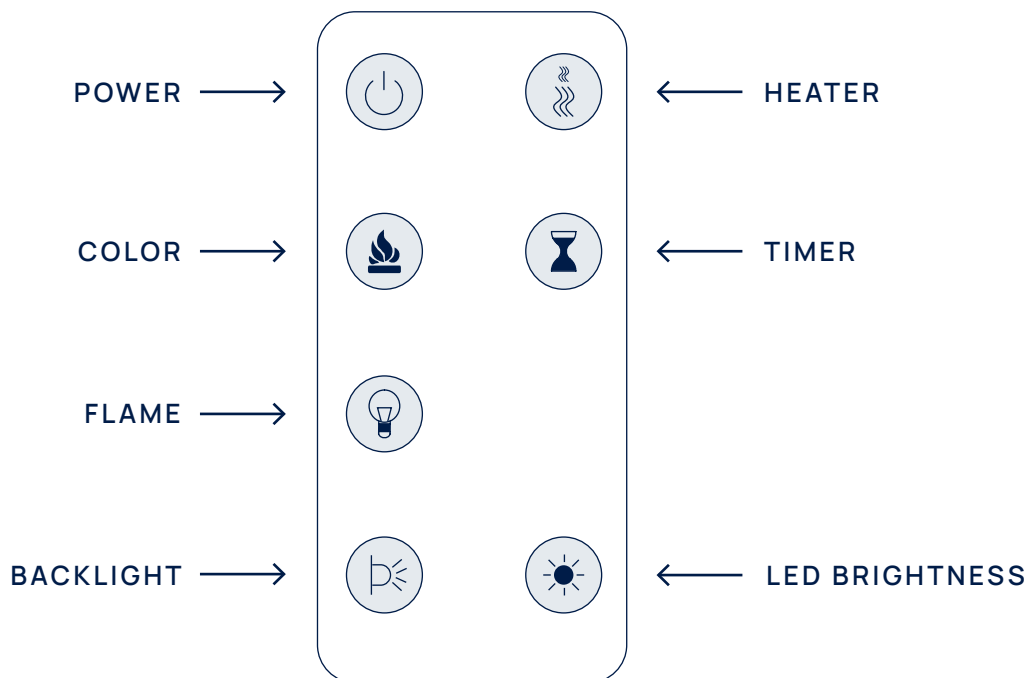

MANUAL PANEL

## REMOTE CONTROL



| BUTTON   | FUNCTION  | ACTION & INDICATION  |
|--|---|--|
| <br>POWER | <p><b>ON:</b> Enables control panel functions and remote control. Turns on flame effect.</p> <p><b>OFF:</b> Disables control panel functions and remote control. Turns off flame effect.</p>    | <ol style="list-style-type: none"> <li><b>Press once:</b> Indicator light turns on. Power turns on. All functions enabled.</li> <li><b>Press again:</b> Flame effect turns off. Unit goes to standby. All functions turn off.</li> </ol> |
| <br>TIMER | <p><b>TIMER BUTTON:</b> Controls timer settings to turn off fireplace at selected time.</p> <p><b>Settings range from 0.5 hours to 7.5 hours.</b></p>   | <ol style="list-style-type: none"> <li><b>Press once:</b> Indicator light turns on. Timer is set to 0.5 hours.</li> <li><b>Press again until desired setting is reached.</b> Indicator lights show setting.</li> </ol>                   |
| <br>FLAME | <p><b>FLAME BUTTON:</b> Makes flame effect dimmer and brighter.</p> <p><b>NOTE:</b> Flame effect stays on until power button is turned off. Flame effect must be on for heater to turn on.</p>  | <ol style="list-style-type: none"> <li><b>Press once:</b> Flame brightness effect gets changing.</li> <li><b>Press again</b> until desired setting is reached.</li> </ol>  |
| <br>COLOR | <p><b>COLOR BUTTON:</b> Changes color of the flame effect.</p> <p><b>NOTE:</b> color effect stays on until power button is turned off. Color flame effect must be on for heater to turn on.</p> | <ol style="list-style-type: none"> <li><b>Press once:</b> Flame color effect gets changing.</li> <li><b>Press again</b> until desired setting is reached. <b>Total 3 colors.</b></li> </ol>  |

## REMOTE CONTROL

| BUTTON  | FUNCTION   | ACTION & INDICATION   |
|---|--|---|
| <br><b>HEATER</b>          | <p><b>HEATER BUTTON:</b> Turns Heater <b>ON</b> and <b>OFF</b>.</p> <p><b>NOTE:</b> The heater only works when the flame effect is on. If the flame effect is off, the heater will not turn on.</p> <p><b>NOTE:</b> To prevent overheating, the heater fan will blow cool air for 8-10 seconds before the heater turns on, and after the heater turns off.</p> | <ol style="list-style-type: none"> <li><b>Press once:</b> Indicator lights up. Fan blows cool air for 10 seconds. 750W heater turns on and blows warm air.</li> <li><b>Press again:</b> Indicator lights up. 1500W heater turns on and blows hot air.</li> <li><b>Press again:</b> Heaters turn off. The fan blows cool air for 10 seconds to allow heater to cool down, then turns off.</li> </ol> |
| <br><b>BACK-LIGHT</b>      | <p><b>BACKLIGHT BUTTON:</b> Changes the decorative LED back lights effect.</p> <p><b>NOTE:</b> This button is available only on remote control.</p>  | <ol style="list-style-type: none"> <li><b>Press once:</b> LED back lights color effect gets changing.</li> <li><b>Press again</b> until desired setting is reached. <b>Total 10 colors.</b></li> </ol>  |
| <br><b>LED BRIGHTNESS</b> | <p><b>LED BRIGHTNESS BUTTON:</b> Dimmer, turn off and on <b>BACK LIGHTS</b>.</p> <p><b>NOTE:</b> Back lights stay on the brightest level when fireplace turns on.</p> <p><b>NOTE:</b> This button is available only on remote control.</p>   | <ol style="list-style-type: none"> <li><b>Press once:</b> Dimmer back lights LED.</li> <li><b>Press again</b> until desired brightness is reached. In total 5 levels. <b>B5 – B4 – B3 – B2 – B1</b></li> <li><b>Press the 5th time</b> LED turns off.</li> <li><b>Press again:</b> Back lights turn on at Level B5.</li> </ol>  |

## REMOTE CONTROL BATTERY INFORMATION

- > Remote control uses one **CR2025 battery** (Included).
- > Instructions for battery installation are on the Remote Control battery compartment.

### CAUTION

- > **NEVER dispose of batteries in fire.**
- > Failure to observe this precaution may result in an explosion. Dispose of batteries at your local hazardous material processing center.

## HOTEL-MODE

- › By using this mode, your individual settings for the following functions will be retained not only after you turn off the power on the touch panel or remote control, but also when you disconnect the power:
  - › **Flame color**
  - › **Flame brightness**
  - › **Backlight Color**
- › The settings for heating, temperature and timer are not saved and are automatically reset to default after power off.

## TEMPERATURE LIMITING CONTROL

- › **This heater is equipped with a Temperature Limiting Control.** Should the heater reach an unsafe temperature, the heater will automatically turn OFF.

### TO RESET

1. Unplug the power cord from the outlet.
2. Turn the ON/OFF switch on the CONTROL PANEL to OFF. Wait 5 minutes.
3. Inspect the fireplace to make sure no vents are blocked or clogged with dust or lint. If they are, use a vacuum to clean the vent areas.
4. Plug the power cord back into the outlet.
5. If the problem continues, have your outlet and wiring inspected by a professional.

## CARE & MAINTENANCE

### CLEANING

#### ⚠ CAUTION

- › **ALWAYS** turn the heater **OFF** and unplug the power cord from the outlet before cleaning, performing maintenance, or moving this fireplace. **Failure to do so could result in electric shock, fire, or personal injury.**
- › **NEVER immerse in water or spray with water.** Doing so could result in electric shock, fire, or personal injury.

#### METAL

- › Buff using a soft cloth, slightly dampened with a citrus oil-based product.
- › **DO NOT** use brass polish or household cleaners as these products will damage the metal trim.

#### GLASS

- › Use a good quality glass cleaner sprayed onto the cloth or towel. Dry thoroughly with a paper towel or lintfree cloth.
- › **NEVER** use abrasive cleansers, liquid sprays, or any cleaner that could scratch the surface.

#### VENTS

- › Use a vacuum or duster to remove dust and dirt from the heater and vent areas.

#### PLASTIC

- › Wipe gently with a slightly damp cloth and a mild solution of dish soap and warm water.
- › **NEVER** use abrasive cleansers, liquid sprays, or any cleaner that could scratch the surface.

## MAINTENANCE

#### ⚠ CAUTION

- › **Risk of electric shock! DO NOT OPEN any panels ! No user-serviceable parts inside!**
- › **ALWAYS** turn the heater **OFF** and unplug the power cord from the outlet before cleaning, performing maintenance, or moving this fireplace. Failure to do so could result in electric shock, fire, or personal injury.

#### ELECTRICAL AND MOVING PARTS

- › The fan motors are lubricated at the factory and will not require lubrication.
- › Electrical components are integrated in the fireplace and are not serviceable by the consumer.

#### STORAGE

- › Store heater in a clean dry place when not in use.

#### ⚠ CAUTION

- › **NO SERVICING of the internal or electrical parts should be performed by the consumer. Do not service the unit yourself.**

## TROUBLESHOOTING

### ⚠ CAUTION

- › Disconnect the appliance completely and let cool prior to any service.
- › Only a qualified service person should service and repair this electric appliance.

| PROBLEM                                      | POSSIBLE CAUSE  | SOLUTION   |
|--|---|--|
| 1. Fireplace turns off and will not turn on. | 1. Fireplace has overheated and safety device has caused thermal switch to disconnect or home circuit breaker has opened. | 1. Reset switch by turning main power switch off and waiting 10 minutes then turning it back on.<br>2. Reset circuit breaker.  |
| 2. Flame is not moving.                      | 1. Wiring is loose.<br>2. Flame motor defective.<br>3. Flamerod out of place.   | 1. Inspect wiring for loose connections.<br>2. Call a qualified service technician to replace flame motor.<br>3. "Flame Rod" out of place due to rough transit/handling of the product. This issue can be corrected as simple as removing the glass, flipping the fireplace upside down, removing a set of screws that are holding the bottom frame plate and placing the flame rod back into place. |
| 3. Flame is not visible.                     | 1. Wiring is loose.   | 1. Disconnect from power source and inspect wiring for loose connections and repair or replace as necessary.<br>2. Push the flame button to high position.   |
| 4. Log set is not glowing.                   | 1. Wiring is loose.<br>2. Ember is in off mode  | 1. Disconnect from power source and inspect wiring for loose connections and repair or replace as necessary.<br>2. Push the ember button to high position.   |
| 5. Remote Control does not work .            | 1. Low batteries<br>2. Not aiming control correctly.<br>3. Defective remote control and/or sensor.                        | 1. Replace batteries in remote control.<br>2. Aim control at sensor located directly behind glass screen in center of unit just above logs.<br>3. Replace remote control and/or sensor.  |

## TROUBLESHOOTING

| PROBLEM   | POSSIBLE CAUSE  | SOLUTION  |
|---|---|---|
| 6. Fireplace will not turn on when switch is flipped to ON. | <ol style="list-style-type: none"> <li>1. Fireplace is not plugged in to an electrical outlet.</li> <li>2. Control failure.</li> <li>3. Breaker tripped.</li> </ol> | <ol style="list-style-type: none"> <li>1. Check plug.</li> <li>2. Call a qualified service technician.</li> <li>3. Reset breaker.</li> </ol>  |
| 7. Heater does not provide heat when turned on.             | <ol style="list-style-type: none"> <li>1. Thermal switch has been tripped.</li> <li>2. Wiring is loose.</li> <li>3. Heater is defective.</li> </ol>                 | <ol style="list-style-type: none"> <li>1. Turn unit off and unplug unit for 10 minutes. Plug back in and turn unit on. If plug cannot be reached, follow directions for tripped circuit breaker.</li> <li>2. Disconnect from power source and inspect wiring for loose connections and repair or replace if necessary.</li> <li>3. Replace heater.</li> </ol> |

### ⚠ CAUTION

- › To remove the glass, you will notice two screws on top sides (right and left) of the fireplace. Once the screws are removed, slide the glass up and away from the fireplace. Once the bottom frame plate is removed, you will notice one flame motor on right side where the rod should be in place with the rubber plugs.
- › Please remember to always have the unit disconnected prior to any work, always lay glass as well as the unit on a towel or other material not to damage parts/frame.
- › This entire process should not take longer than **20-30 minutes**.